

力平（导轨压块）可以简单的调整 直线导轨的直线度

安装直线导轨时，对其直线度的调整比较麻烦，但是使用了我们的力平（导轨压块）以后，可以比较简单快速的达到安装调整的较佳佳效果。并且我们已经申请了外观专利专利号为（201730238928.8）。
亚母斯为您提供直线导轨和直线滑块安装固定的标准件—力平（导轨压块），它是现在一种便捷、廉价、精确的固定安装方式。
由于它独特的圆锥面接触锁紧使其达到安装固定的最佳状态。
用户只需按亚母斯为您提供的尺寸打螺孔加工，然后装上亚母斯的“力平（导轨压块）”，便可实现精确定位锁紧的目的了。

Liping can adjust the straightness of linear roller easily. When the Linear roller is installed, the adjustment of its straightness is too much trouble, but the use of Liping later, can be relatively simple and quickly to adjust to meet the best results. And we have applied for the appearance patent, the patent number is (201730238928.8)

Liping now is our patented product. AMS provides you with linear guide and linear slider fixed. standard parts—Liping, which is now one of the most convenient, cheapest and most precise way of a fixed installation.

Because of its unique locking taper contact, it is able to reach the best status fixed.

Users only need to follow the size provided by Li Ao, then load on Liping produced by Lio, it will be able to achieve precise positioning of the purpose of locking.

证书号第8503196号



外观设计专利证书

外观设计名称：直线导轨定位装置

设计人：丁太虎

专利号：ZL 2023 3 0476006.6

专利申请日：2023年07月28日

专利权人：威海亚母斯自动化设备有限公司

地址：264200 山东省威海市临港区草庙子镇开元西路1号

授权公告日：2024年02月20日

授权公告号：CN 308476380 S

国家知识产权局依照中华人民共和国专利法经过初步审查，决定授予专利权，颁发外观设计专利证书并在专利登记簿上予以登记。专利权自授权公告之日起生效。专利权期限为十五年，自申请日起算。

专利证书记载专利权登记时的法律状况，专利权的转移、质押、无效、终止、恢复和专利权人的姓名或名称、国籍、地址变更等事项记载在专利登记簿上。



局长
申长雨

申长雨



第1页(共2页)

其他事项参见续页

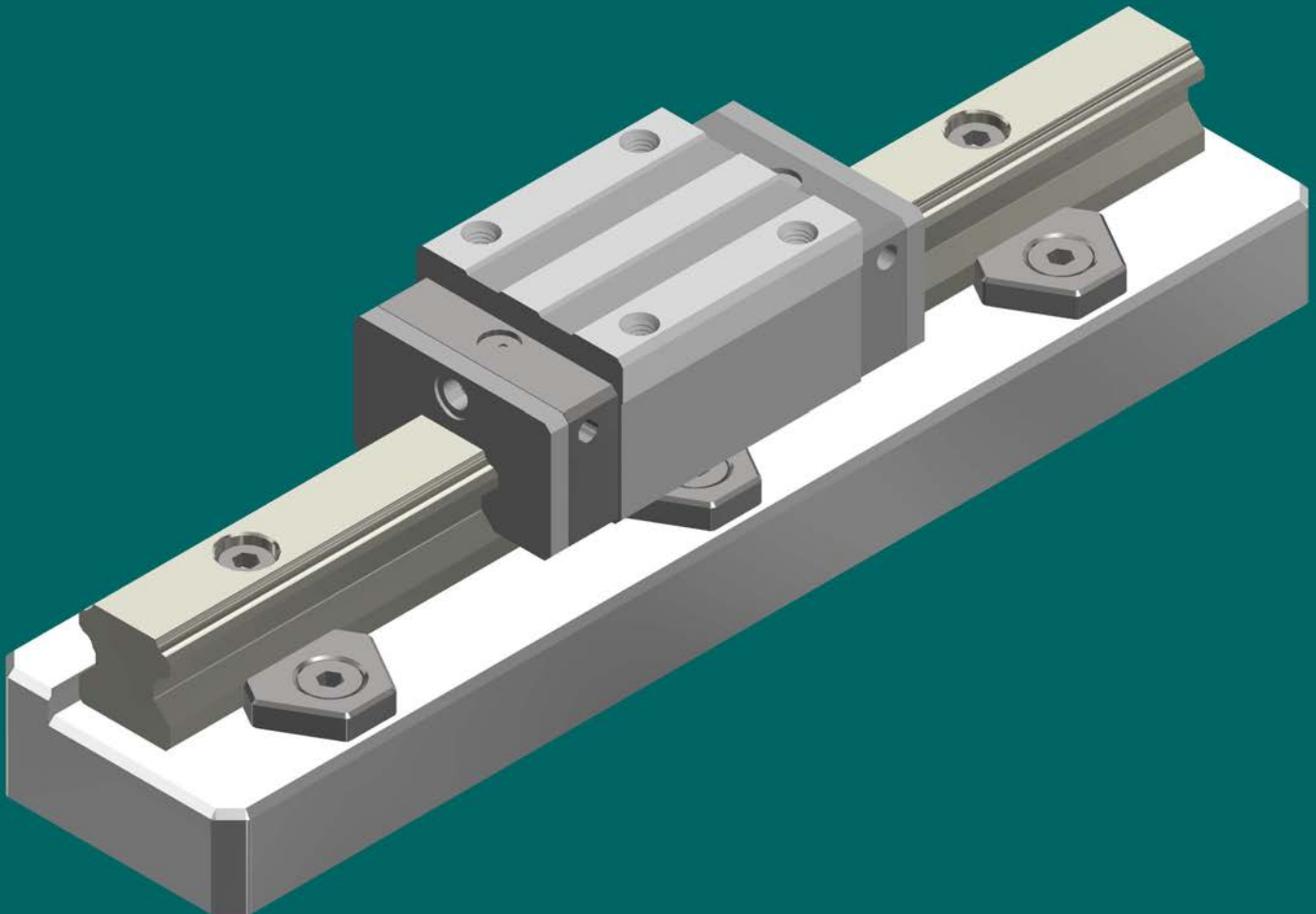

力平（导轨压块）是靠平面接触方式将直线导轨及滑块安装在结合面上的锁紧部件。LIPING is a lock part that the linear guide by plane touching and be installed on the join surface.

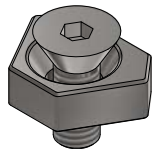

- LP-4产品采用特殊锌合金材质制作，表面经过镀层处理，在一般环境下不会生锈。由于其硬度低于普通线性导轨表面硬度，设计上不会对线性导轨表面产生任何影响。此外，与相关产品LP-P相比，价格更加便宜，具有经济性。

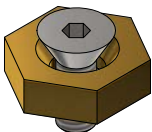

- LP-P 产品采用坚固的黄铜材质制作，无论在何种环境条件下都不会生锈。由于其惯性矩大，适用于冲击和振动较多的CNC机床使用，可部分吸收传递到线性导轨的振动。



- 这次开发并开始销售的LP-B产品获得了外观专利。经过表面处理，在一般环境下不会生锈。此产品能够以最低的成本防止直线轨道的移动。

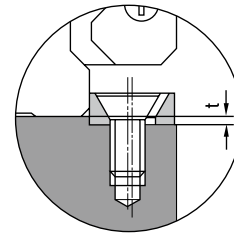
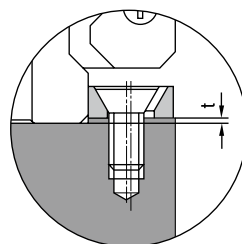
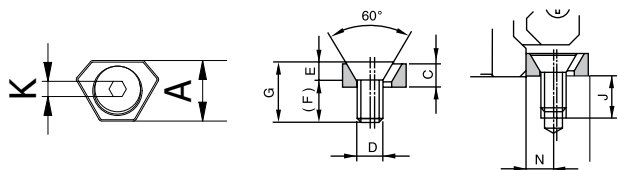

力平（导轨压块）各部分尺寸参数请见下表
All dimension parameter of LIPING are as following.

铣凸台解决安装高度问题
solve the installing height problem by milling protruded flat.

铣凹台解决安装高度问题
solve the installing height problem by milling hollow flat.

型号 Type	A	C	D	E	螺孔倒角 screw facet	G	N	J	K	安装最大扭矩 Max Torque (kgf cm)	锁紧力 Clamping Force(kgf)
LP0404-4	14	4	M4	(3)	C1	10	6.3	8	2.5	30	120
LP0505-4	14	5	M5	(4)	C1	14	6.3	10	3	60	170
LP0606-4	16	6	M6	(5)	C1	16	7.3	11	4	100	220
LP0808-4	20	8	M8	(6.5)	C1	25	9.3	19	5	190	290
LP0810-4	20	10	M8	(6.5)	C1	25	9.3	19	5	190	350
LP1012-4	24	12	M10	(8.5)	C1	30	11.3	22	8	300	480

注意) “t”是客户需要注意的地方，力平是没有这个数据。

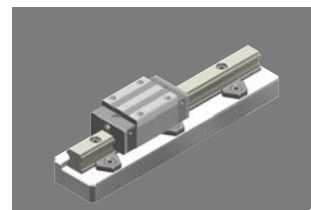



力平（导轨压块）作为一标准件出现在该行业中。它为您提供廉价、便捷、精确的直线导轨的安装方式。

LIPING appears among this trade as a standard part and it supplies the cheapest, the most convenient and the most accuracy installation of linear guide.

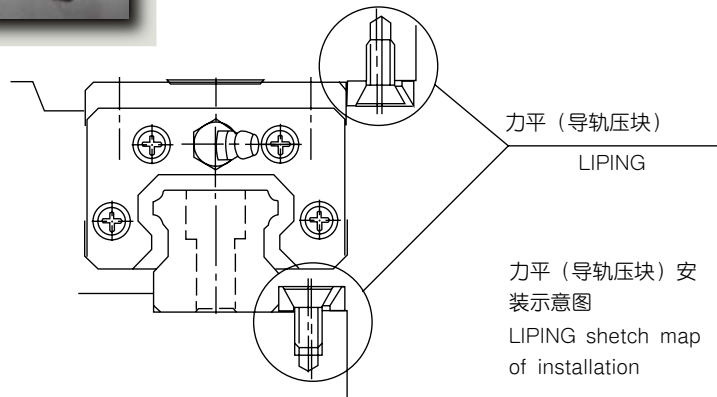
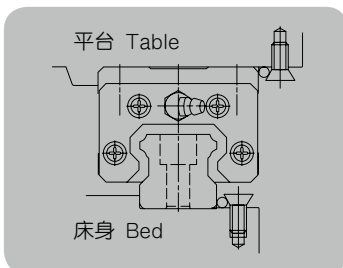
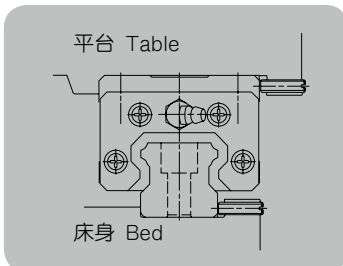
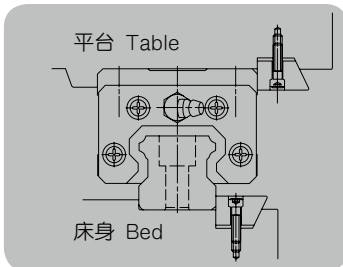
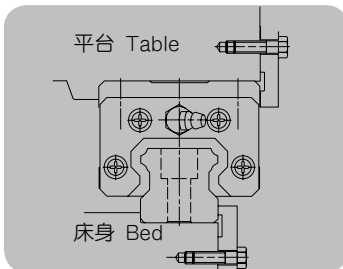









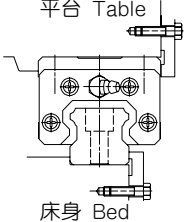

3D测量设备中力平使用照片

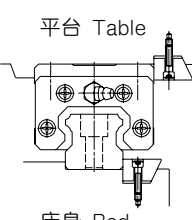
直线导轨和滑块的固定方式 THE FIXED WAY OF LINEAR GUIDE AND LINEAR BLOCK

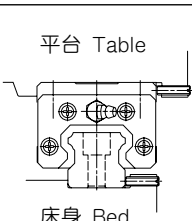

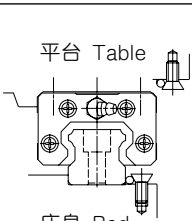
在有机械振动、冲击等场合, 直线导轨和滑块有如下的固定方式。

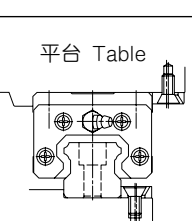
The fixed way of machining vibration striking linear guide and block as following:

结构 structure	使用方法 Using	固定锁紧形式 Fixed lock form	受力方向 Forcing Direction
 <p>平台 Table</p> <p>床身 Bed</p>	<p>这是一种比较常用的固定方式。为使定位块与滑块和导轨接触良好, 定位块上必须加铣空刀槽, 结合面还必须精密研磨方可准确定位, 这样便造成了加工麻烦, 费用增加。 This is a fixed way in common use. Locating block must be added milling slot and the joining surface must be skived in order to touch together well and locate accurately. Then it is not very convenient to machine and the freight will be increased.</p>	<p>面接触 Facing touching</p>	
 <p>平台 Table</p> <p>床身 Bed</p>	<p>由于这种安装方式固定块斜面受力很大, 易造成机床导轨安装面和滑块安装面的受力变形, 并且固定块及机床床身、平台的斜面等所有接触面都必须精密的磨削加工, 这样便造成加工成本的提高, 以及安装时注意事项较多。 Since the fixed slant forcing strong using this installation which could cause distortion of the block bed, table installing face must be burnished minutely, then its freight will be increased and it is also not convenient.</p>	<p>面接触 Facing touching</p>	
 <p>平台 Table</p> <p>床身 Bed</p>	<p>这种固定方式, 由于螺栓旋转锁紧的螺栓顶端与导轨固定接触面较小锁紧时易造成接触面的划伤。因而影响了定位精度。 The fixed accuracy of this way has been infeted because the touching face is more smaller between the screw's top and guide and it maybe breaks when locking.</p>	<p>旋转螺栓的圆柱面接触 Facing touching between rolling bolt and bolt's surface</p>	
 <p>平台 Table</p> <p>床身 Bed</p>	<p>通过螺栓旋转后产生了一个如图所示的受力情况, 以达到锁紧滑块和导轨的目的, 这样安装易使螺帽很快损坏, 并造成了结合面的划伤, 以致于降低定位精度。 It produces one force according to the figure in order to lock the block and the guide. It can break the screw cap and break the join face reducing the fixed accuracy.</p>	<p>线接触 Lining touching</p>	
 <p>平台 Table</p> <p>床身 Bed</p>	<p>亚母斯为您提供直线导轨和直线滑块安装固定的标准件——力平 (导轨压块)。它是当今便捷、廉价、精确的固定安装方式。由于它独特的圆锥面接触锁紧使其达到安装固定的最佳状态。用户只需按亚母斯为您提供的打螺孔尺寸加工, 然后装上, 便可实现了精确定位锁紧的目的了。 AMS supplies you the standard parts of fixed linear guide and liner block—liping. It is the most convenient cheapest and the most accuracy installation. It can be up to the best states because its taper locking and the good material.</p>	<p>面接触 Facing touching</p>	

选定产品后相关技术参数请再次咨询亚母斯 (AMS) 确认, 更多新产品请查阅亚母斯 (AMS) 官方网站

想要了解产品技术信息请登录网站下载

WWW.AMS88.COM
咨询电话:0631-5927833

力平（导轨压块）是靠平面接触方式将直线导轨及滑块安装在结合面上的锁紧部件。LIPING is a lock part that the linear guide by plane touching and be installed on the join surface.

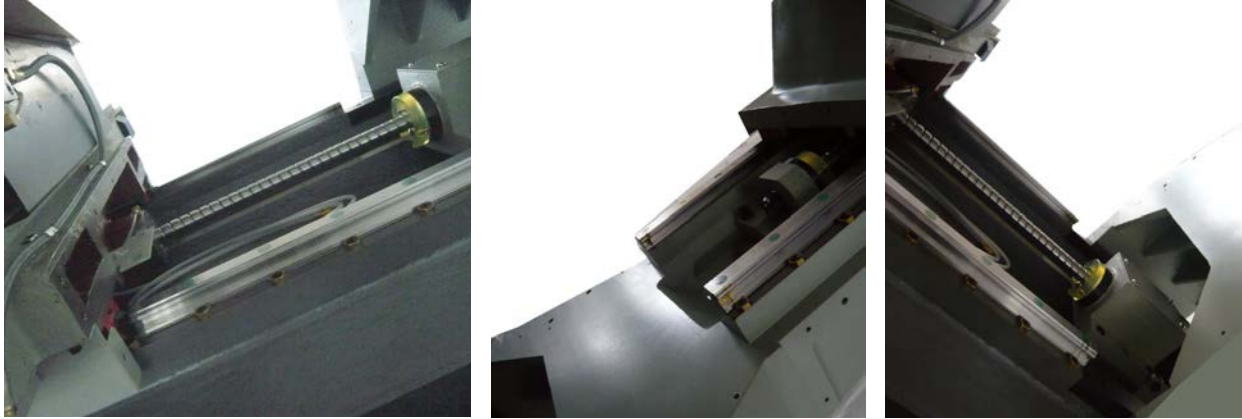

力平（导轨压块）在实际中的应用

LIPING Application

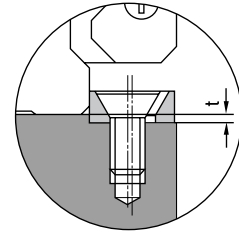
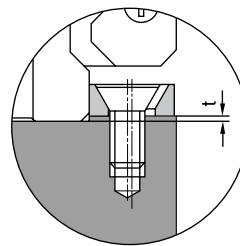
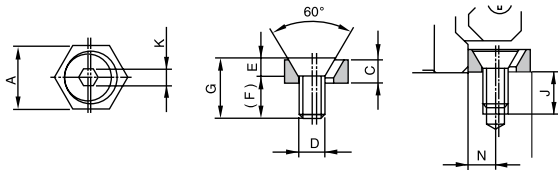

力平（导轨压块）各部分尺寸参数请见下表
All dimension parameter of LIPING are as following.

铣凸台解决安装高度问题
solve the installing height problem by milling protruded flat.

铣凹台解决安装高度问题
solve the installing height problem by milling hollow flat.

型号 Type	A	C	D	E	螺孔倒角 screw facet	G	N	J	K	安装最大扭矩 Max Torque (kgf cm)	锁紧力 Clamping Force(kgf)
LP0404-P	14	4	M4	(3)	C1	10	6.3	8	2.5	30	120
LP0505-P	14	5	M5	(4)	C1	14	6.3	10	3	60	170
LP0606-P	16	6	M6	(5)	C1	16	7.3	11	4	100	220
LP0808-P	20	8	M8	(6.5)	C1	25	9.3	19	5	190	290
LP0810-P	20	10	M8	(6.5)	C1	25	9.3	19	5	190	350
LP1012-P	24	12	M10	(8.5)	C1	30	11.3	22	8	300	480

注意) “t” 是客户需要注意的地方，力平是没有这个数据。



直线导轨和滑块的固定方式 THE FIXED WAY OF LINEAR GUIDE AND LINEAR BLOCK

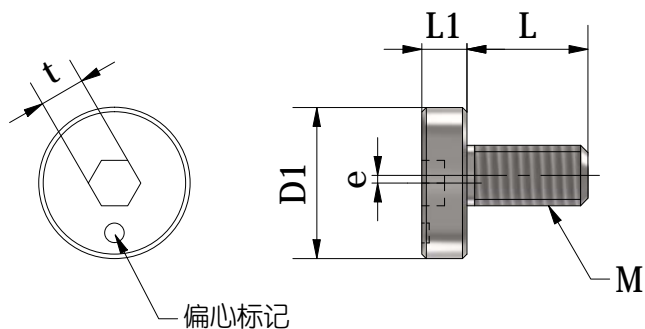

● 材质、表面处理

材质 : SCM435
 表面处理 : 无电解镀镍
 强度等级 : 10.9

单位: mm

LP-B		共通尺寸										每包数量
型号	型号	M(粗牙)		L	D ₁	L ₁	e	适用扳手	t	质量(g)		
		螺纹公称直径	螺距									
LP0404-B		M4	0.7	8	10	3	0.5	3		3	1.6	100
LP0505-B		M5	0.8	10	12	4	0.5	4		4	2.6	100
LP0606-B		M6	1	12	13	4	0.5	4		4	5.1	100

● 安装尺寸

单位: mm

型号	E	M	调节范围 min. / max.	s max.
LP0404-B	4.65	M4	-0.05 / 0.75	4.1
LP0505-B	5.65	M5	-0.05 / 0.75	5.3
LP0606-B	6.15	M6	-0.15 / 0.85	5.5

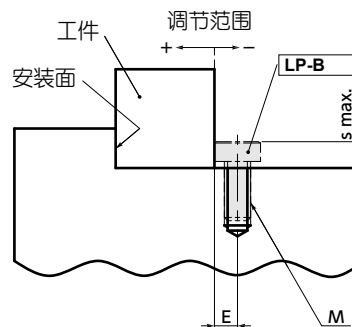

● 安装方法

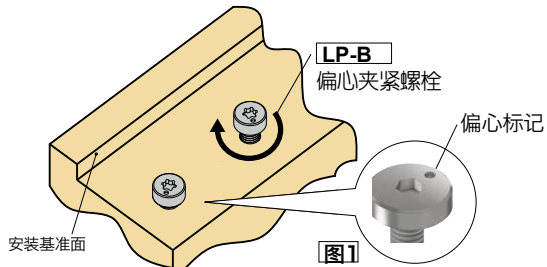

1 请将偏心夹紧螺栓拧进螺孔，直至螺栓的头部轻触底座面 图 1。此时，即使偏心标记的位置不一致也没有关系。

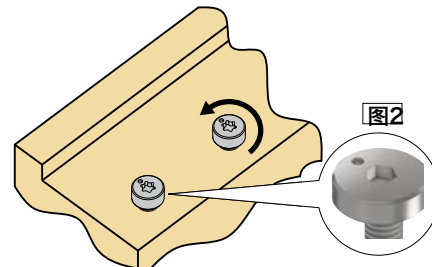

2 请旋松偏心夹紧螺栓，让偏心标记位于 图 2 的位置。

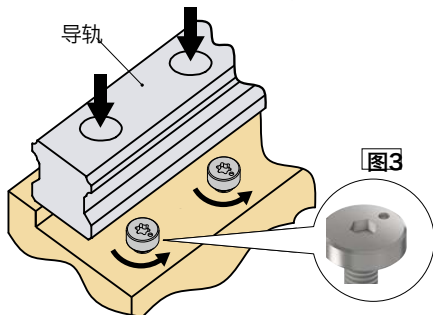

3 为将偏心标记旋松至图 2 位置，请将想要安装的图 3 导轨插入偏心夹紧螺栓与安装基准面之间。

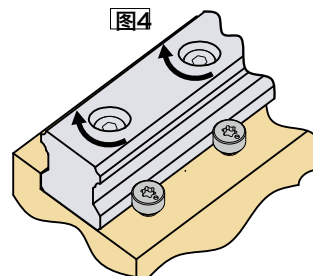

4 请将导轨主体的安装螺栓 图 4。临时紧固

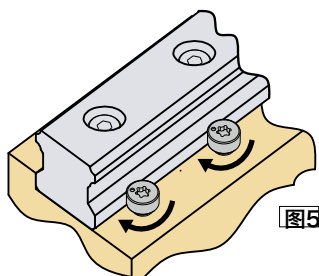

5 请紧固偏心夹紧螺栓，使导轨紧贴 图 5 安装基准面

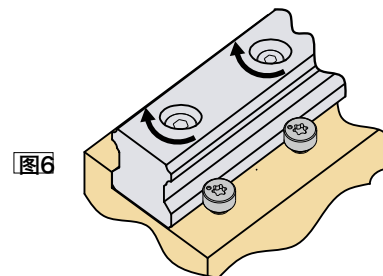

6 请正式紧固导轨主体的安装螺栓 图 6

● 使用例

直线导轨用轨道的固定。

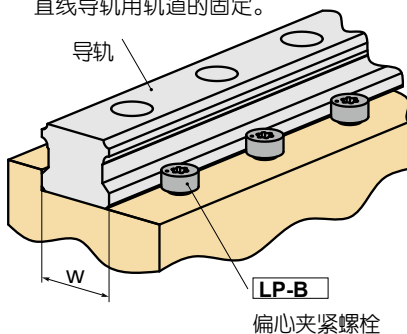

- 参见安装尺寸的s max.尺寸，偏心夹紧螺栓可能与线轨滑座等接触时，请降低偏心夹紧螺栓的安装面以避免接触。
- 使用于导轨时，请压在导轨主体安装螺栓的位置。

● 线性导轨用导轨的推荐尺寸

单位：mm

导轨公称尺寸	轨道宽度 W	适用偏心夹紧螺栓	
		标准型号	升级型号
#20	20	LP0404-B	LP0405-B
#25	23	LP0505-B	LP0406-B
#30	28	LP0606-B	LP0408-B

由于各公司的直线轨道高度 "K" 数值不同，因此可以自由选择螺栓。目前，我公司已开发出三种规格，并计划根据市场需求不断升级。

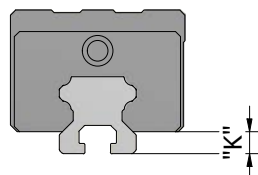

选定产品后相关技术参数请再次咨询亚母斯 (AMS) 确认，更多新产品请查阅亚母斯 (AMS) 官方网站

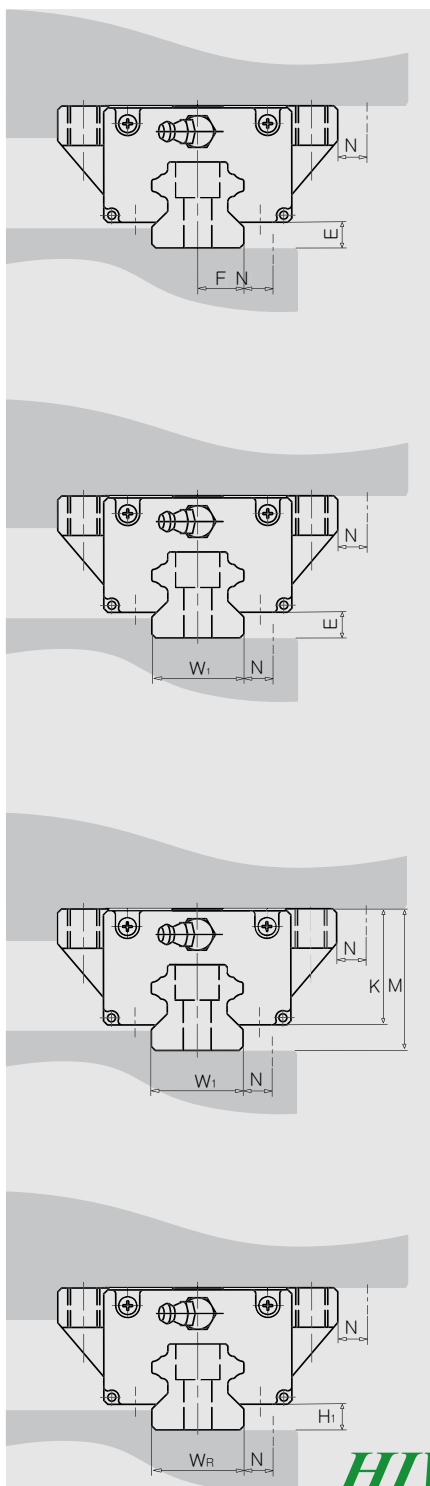

AMS
Automatic Motion System

Linear Rail System

SBC

THK

HIWIN®

AMS			
型号	E	F	相对应的力平型号
AMG15	2.65	7.50	—
AMG20	3.50	10.00	—
AMG25	5.00	11.50	LP0404
AMG30	6.50	14.00	LP0606
AMG35	7.50	17.00	LP0606
AMG45	7.30	22.50	LP0606
AMG55	9.80	26.50	LP0808
AMG65	17.50	31.50	LP01012

SBC			
型号	E	W1/2	相对应的力平型号
SBG15	2.65	7.50	—
SBG20	3.50	10.00	—
SBG25	5.00	11.50	LP0404
SBG30	6.50	14.00	LP0505/LP0606
SBG35	7.50	17.00	LP0606
SBG45	7.30	22.50	LP0606
SBG55	9.80	26.50	LP0808
SBG65	17.50	31.50	LP01012

THK			
型号	M-K	W1/2	相对应的力平型号
HSR15	4.70	7.50	LP0404
HSR20	4.00	10.00	—
HSR25	5.50	11.50	LP0505
HSR30	7.00	14.00	LP0606
HSR35	7.50	17.00	LP0606
HSR45	10.00	22.50	LP0808
HSR55	13.00	26.50	LP01012
HSR65	14.00	31.50	LP01012
HSR85	16.00	42.50	LP01012

HIWIN			
型号	H1	WR/2	相对应的力平型号
HGW15	4.30	7.50	LP0404
HGW20	4.60	10.00	LP0404
HGW25	5.50	11.50	LP0505
HGW30	6.00	14.00	LP0505
HGW35	7.50	17.00	LP0606
HGW45	9.50	22.50	LP0808
HGW55	13.00	26.50	LP01012
HGW65	15.00	31.50	LP01012

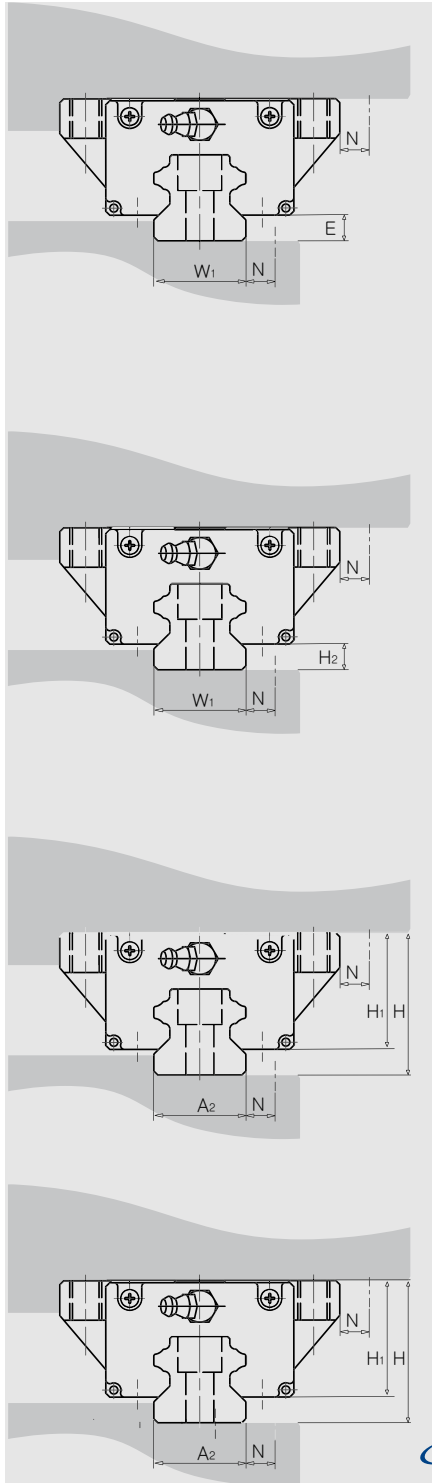

ABBA			
型号	E	W1/2	相对应的力平型号
BRH15	4.60	7.50	LP0404
BRH20	5.00	10.00	LP0404
BRH25	7.00	11.50	LP0606
BRH30	9.00	14.00	LP0808
BRH35	9.50	17.00	LP0808
BRH45	14.00	22.50	LP01012
BRH55	15.00	26.50	LP01012



AMT			
型号	H2	W1/2	相对应的力平型号
MSA15A/LA	4.20	7.50	LP0404
MSA20A/LA	5.00	10.00	LP0404
MSA25A/LA	6.50	11.50	LP0505/LP0606
MSA30A/LA	8.00	14.00	LP0606
MSA35A/LA	9.50	17.00	LP0808
MSA45A/LA	10.00	22.50	LP0808
型号	H2	W1/2	相对应的力平型号
MSB15E/TE	4.50	7.50	LP0404
MSB20E/TE	6.00	10.00	LP0505
MSB25E/TE	7.00	11.50	LP0606
MSB30E/TE	9.50	14.00	LP0808



STAR			
型号	H-H1(E)	A2/2	相对应的力平型号
15	4.10	7.50	—
20	4.65	10.00	LP0404
25	6.10	11.50	LP0505
30	6.65	14.00	LP0606
35	7.60	17.00	LP0606
45	9.70	22.50	LP0808



TOMSON			
型号	H-H1	A2/2	相对应的力平型号
30	4.50	14.00	LP0404
35	5.50	17.00	LP0505
45	7.00	22.50	LP0606
55	7.50	26.50	LP0606
65	10.00	31.50	LP0808

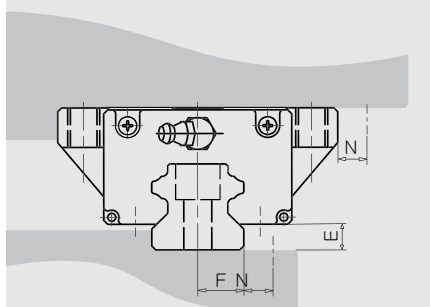
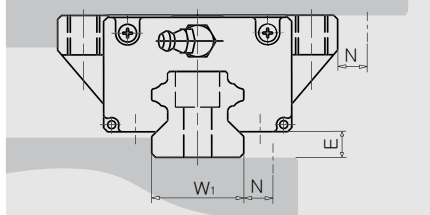
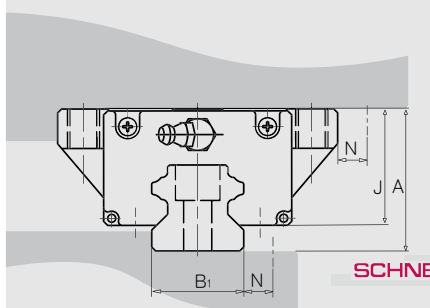
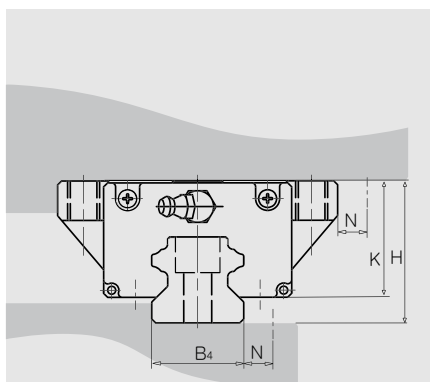

南京工艺			
型号	H-K	B4/2	相对应的力平型号
GZA20	6.00	10.00	LP0505
GZA20	6.70	11.50	LP0606
GZA20	7.00	14.00	LP0606
GZA20	10.00	17.00	LP0808
GZB35	6.00	17.00	LP0505
GZB45	8~10	22.50	LP0808
GZB55	10.00	26.50	LP0808
GZB65	14.00	31.50	LP01012
GZB30	7.00	14.00	LP0606
GZB35	11.50	17.00	LP0808/LP0810
GZB45	11.60	22.50	LP0810
GZB55	14.00	26.50	LP01012

SCHNEEBERGER(施耐博格)			
型号	A-J	B1/2	相对应的力平型号
MRA/C25	6.50	11.50	LP0606
MRA/C35	8.00	17.00	LP0606
MRA/C45	10.00	22.50	LP0808
MRA/C55	13.00	26.50	LP01012
MRA/C65	14.00	31.50	LP01012

NSK			
型号	E	W1/2	相对应的力平型号
LH15	4.60	7.50	LP0404
LH20	5.00	10.00	LP0404
LH25	7.00	11.50	LP0606
LH30	9.00	14.00	LP0808
LH35	9.50	17.00	LP0808
LH45	14.00	22.50	LP01012
LH55	15.00	26.50	LP01012
LH65	16.00	31.50	LP01012
LH85	18.00	42.50	LP01012

STAF			
型号	E	W1/2	相对应的力平型号
H15	3	7.5	—
S15	3	7.5	—
H20	4.5	10	LP0404
S20	4.5	10	LP0404
H25	5.8	11.5	LP0505
S25	5.8	11.5	LP0505
H30	7	14	LP0606
H35	7.5	17	LP0606

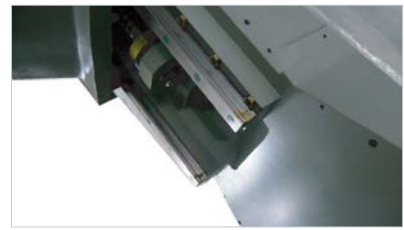
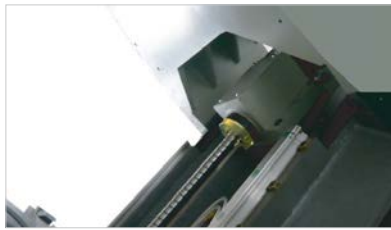
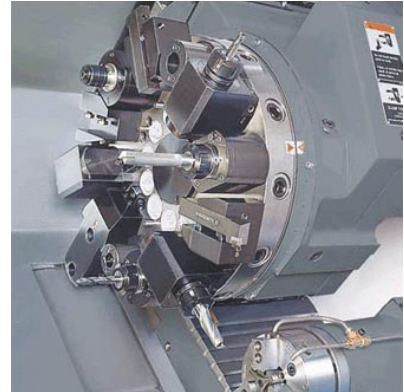

亚姆斯 (AMS) 导轨不用加油, 不生锈, 噪音低, 振动小, 重量轻, 高速度, 无磁性, 适用于潮湿、粉尘、木屑等恶劣环境。

AMS
AMS WON

WWW.AMS88.COM



选定产品后相关技术参数请再次咨询亚姆斯 (AMS) 确认, 更多新产品请查阅亚姆斯 (AMS) 官方网站

想要了解产品技术信息请登录网站下载

WWW.AMS88.COM
咨询电话:0631-5927833

世界首个直线运动系统的创新技术! 中国直线运动创始人家

亚姆斯(AMS)中国代理网



WWW.AMS88.COM

请确认抖音道人的视频!